



Electrolux
PROFESSIONAL

**Modular Cooking Range Line
thermaline 90 - Electric Warming
Plate Top, 1 Side**

ITEM # _____

MODEL # _____

NAME # _____

SIS # _____

AIA # _____



589144 Electric Warming Plate, 1-sided operated, 2/1
(MCRBAAJOB0) GN

Main Features

- THERMODUL connection system creates a seamless work top when units are connected to each other thus avoiding soil penetrating vital components and facilitating the removal of units in case of replacement or service.
- Metal knobs with embedded hygienic "soft-touch" grip for easier handling and cleaning. The special design of the controls prevents infiltration of liquids or soil into vital components.
- Fast deployment with full heating power immediately.
- The smooth glass-ceramic surface can be quickly and easily cleaned, thus providing maximum hygiene.
- Almost the entire surface of the ceramic plate can be used without "dead" spots.
- Pans can easily be moved from one area to another without lifting.
- All major components may be easily accessed from the front.
- Overheat protection via a temperature sensor that switches off part of the heating element in the event of over temperature. Temperature range from 30°C to 110°C.

Construction

- 2 mm top in 1.4301 (AISI 304).
- Unit constructed according to DIN 18860_2 with 20 mm drop nose top and 70 mm recessed plinth.
- Flat surface construction with minimal hidden areas to easily clean all surfaces
- Internal frame for heavy duty sturdiness in 1.4301 (AISI 304).
- Unit constructed according to DIN 18860_2 with 20 mm drop nose top.
- IPX5 water resistance certification.

Optional Accessories

- Scraper for cook tops PNC 910601
- Connecting rail kit, 900mm PNC 912502
- Portioning shelf, 1000mm width PNC 912528
- Portioning shelf, 1000mm width PNC 912558
- Folding shelf, 300x900mm PNC 912581
- Folding shelf, 400x900mm PNC 912582
- Fixed side shelf, 200x900mm PNC 912589
- Fixed side shelf, 300x900mm PNC 912590
- Fixed side shelf, 400x900mm PNC 912591
- Connecting rail kit: modular 90 PNC 912975
(on the left) to ProThermetic tilting
(on the right), ProThermetic
stationary (on the left) to
ProThermetic tilting (on the right)
- Connecting rail kit: modular 80 PNC 912976
(on the right) to ProThermetic
tilting (on the left), ProThermetic
stationary (on the right) to
ProThermetic tilting (on the left)
- Endrail kit, flush-fitting, left PNC 913111

APPROVAL: _____



Experience the Excellence
www.electroluxprofessional.com



Electrolux
PROFESSIONAL

Modular Cooking Range Line thermaline 90 - Electric Warming Plate Top, 1 Side

- Endrail kit, flush-fitting, right PNC 913112
- Endrail kit (12.5mm) for thermaline 90 units, left PNC 913202
- Endrail kit (12.5mm) for thermaline 90 units, right PNC 913203
- T-connection rail for back-to-back installations without backsplash (to be ordered as S-code) PNC 913227
- Insert profile d=900 PNC 913232
- Endrail kit, (12.5mm), for back-to-back installation, left PNC 913251
- Endrail kit, (12.5mm), for back-to-back installation, right PNC 913252
- Endrail kit, flush-fitting, for back-to-back installation, left PNC 913255
- Endrail kit, flush-fitting, for back-to-back installation, right PNC 913256
- Filter W=1000mm PNC 913666



Modular Cooking Range Line
thermaline 90 - Electric Warming Plate Top, 1 Side

The company reserves the right to make modifications to the products without prior notice. All information correct at time of printing.

2026.06.17

Front

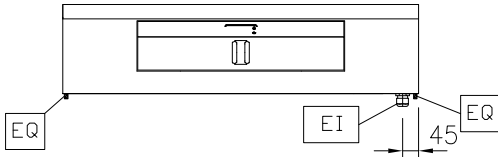

Side

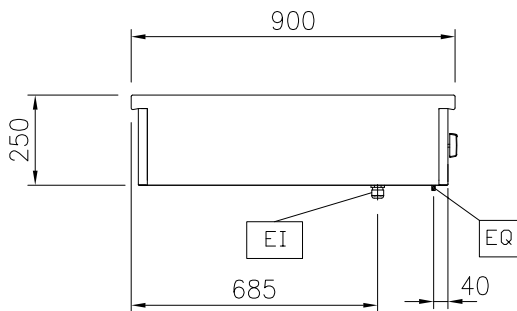

EI = Electrical inlet (power)
 EQ = Equipotential screw

Top

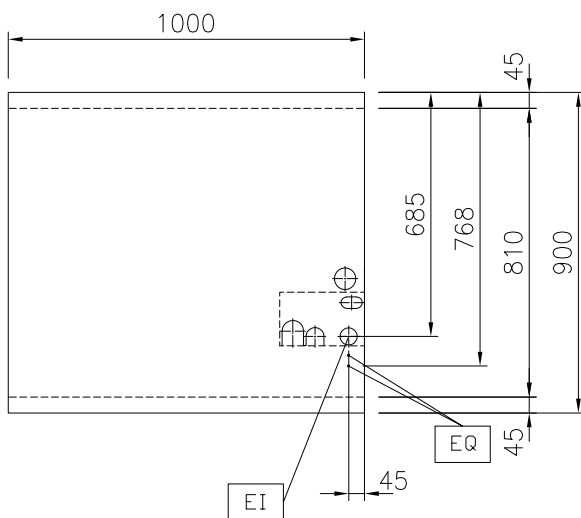

Electric

Supply voltage: 230 V/1N ph/50/60 Hz
 Total Watts: 0.95 kW

Key Information:

External dimensions, Width: 1000 mm
 External dimensions, Depth: 900 mm
 External dimensions, Height: 250 mm
 Net weight: 42 kg
 Configuration: One-Side Operated;Top
 Front Plates Power: 0 - 0 kW
 Front Plates dimensions:

Sustainability

Current consumption: 4.13 Amps